

Bear Den Gazebo

#492 - KM-BDG-GR



1-2 PERSON
ASSEMBLY

FIRE AND SAFETY PRECAUTIONS:

- Always ensure the gazebo is firmly secured to the ground before use.
- Always use external tie-downs and stakes to secure your gazebo.
- This gazebo is designed for temporary use only and not as a permanent structure.
- Never leave the gazebo unattended when raining or during windy conditions.
- Do not allow water to collect on the canopy roof, as this may cause the structure to collapse.

WARNING: THIS GAZEBO IS NOT FIREPROOF. KEEP AWAY FROM NAKED FLAMES AT ALL TIMES.

- Do not smoke in or near the gazebo.
- Do not place hot appliances in or around the gazebo.
- Do not use open flame heaters in your gazebo.
- Fabric will melt when contact is made with hot surfaces.

WARNING: Injury or death may result from fire if tent fabric is exposed to open flame. Tent fabric is not fireproof. Fabric will burn with extended exposure to open flame. Do not use open flame products inside tent.

CARE INSTRUCTIONS:

- **FRAME:** Wipe down with fresh water after use.
- **CANOPY:** Use a sponge with fresh water and mild detergent.
- Allow to dry thoroughly before storing.
- Do not store when wet.

WARNING: The UPF50+ rating is for the canopy material only. The amount of sun protection received will vary depending on the correct positioning of the gazebo. Please note the suggested positioning. Reflective rays can also cause sun burn. Sunscreen should be worn at all times.

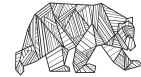
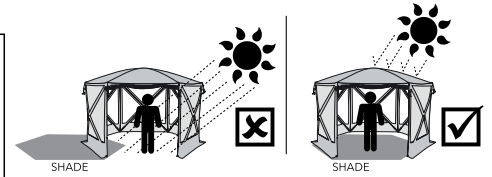

KUMA
OUTDOOR GEAR

kumaoutdoorgear.com

ASSEMBLY INSTRUCTIONS

1 Fold out Gazebo.

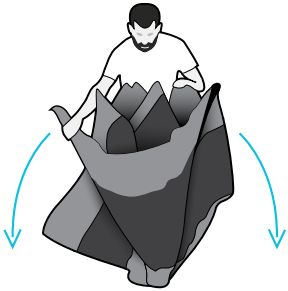

2 Lay out Gazebo walls.

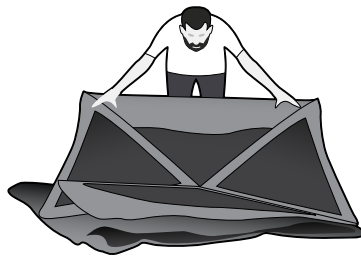

3 Pop out Gazebo walls x 5.
(Do not pop up top yet!)

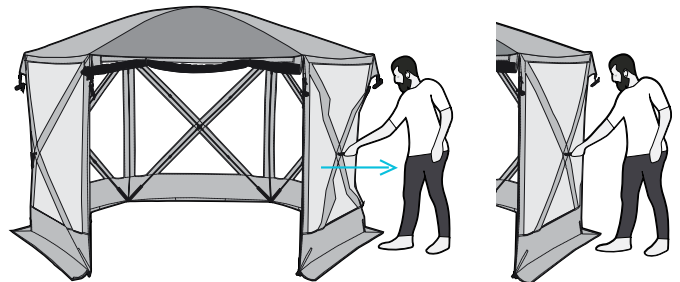

4 Insert the poles into the roof and door.

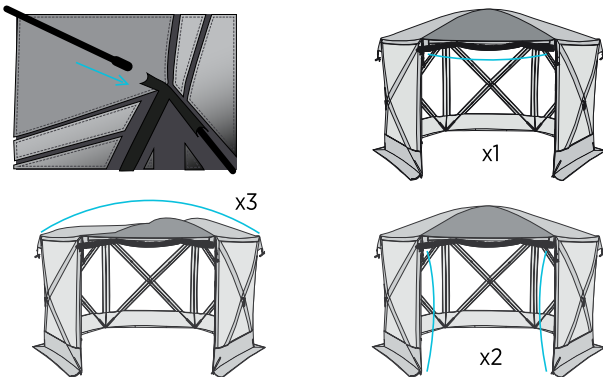

5 Pop up the centre firmly.

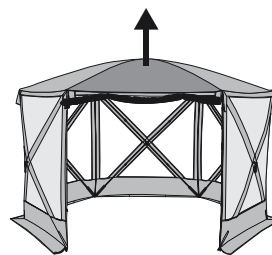

6 Peg down the Gazebo at the base of each corner. Use the guy ropes and pegs to secure firmly.

